

FIG.1

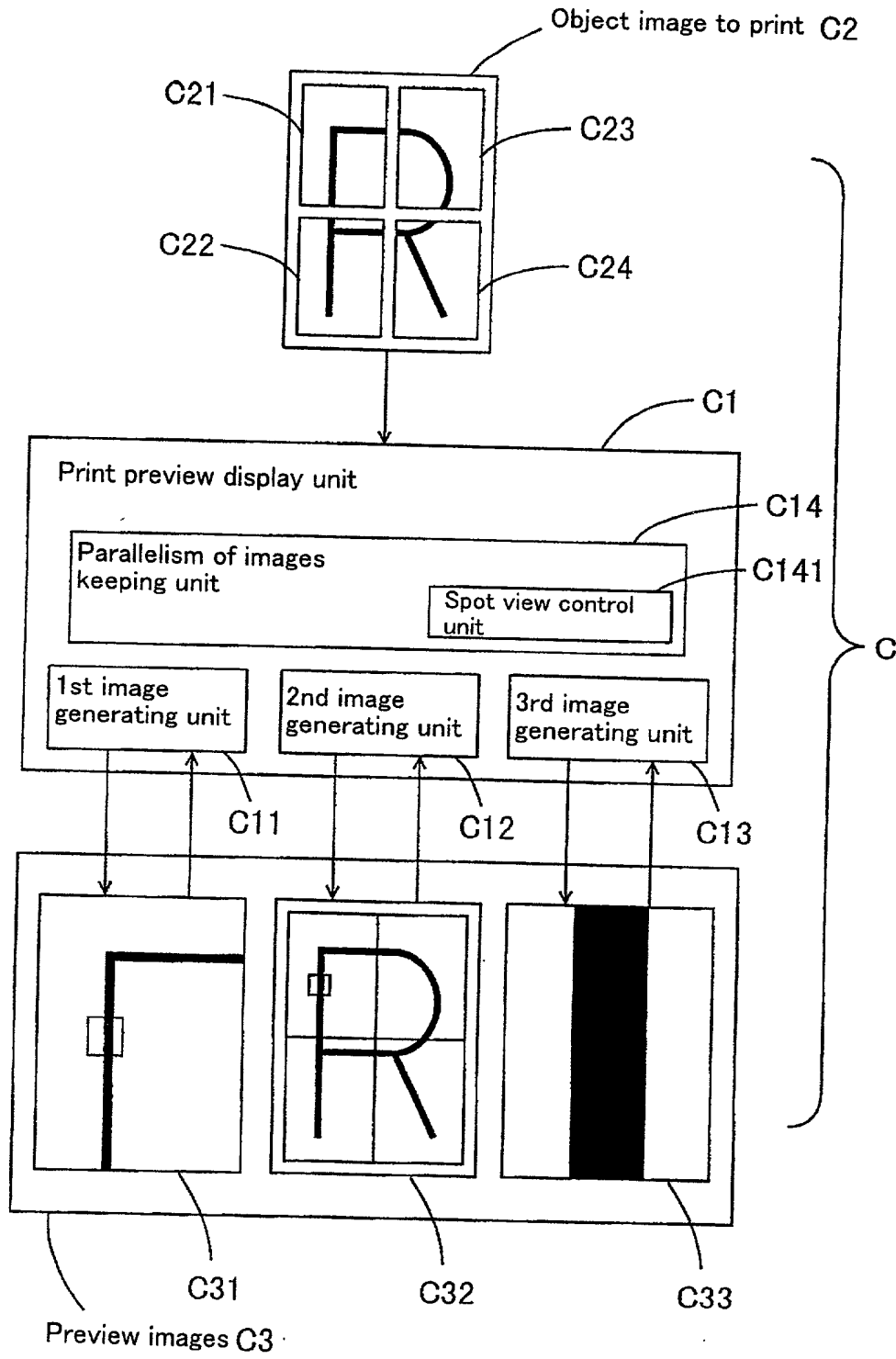

FIG.1

FIG.2

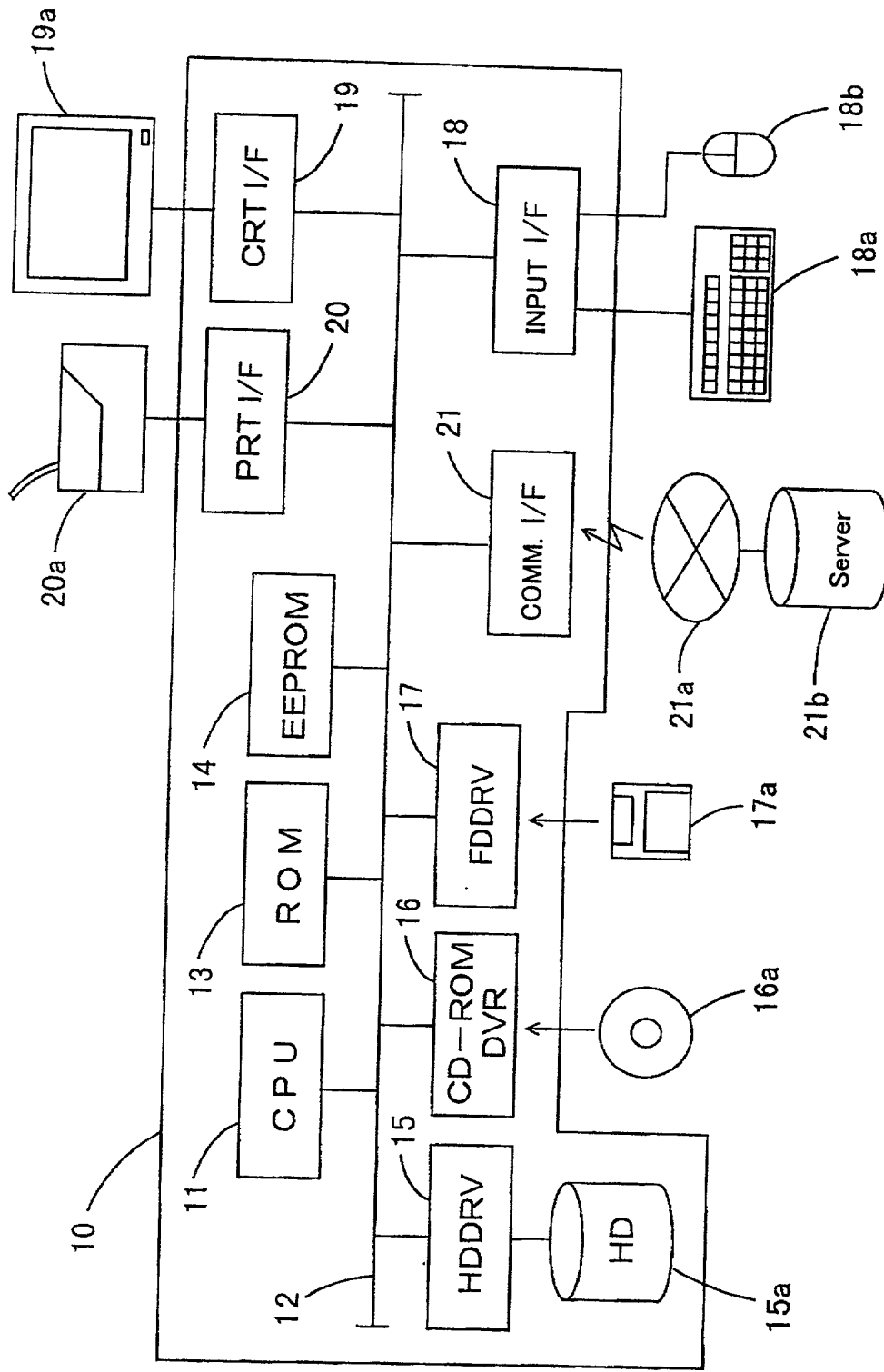
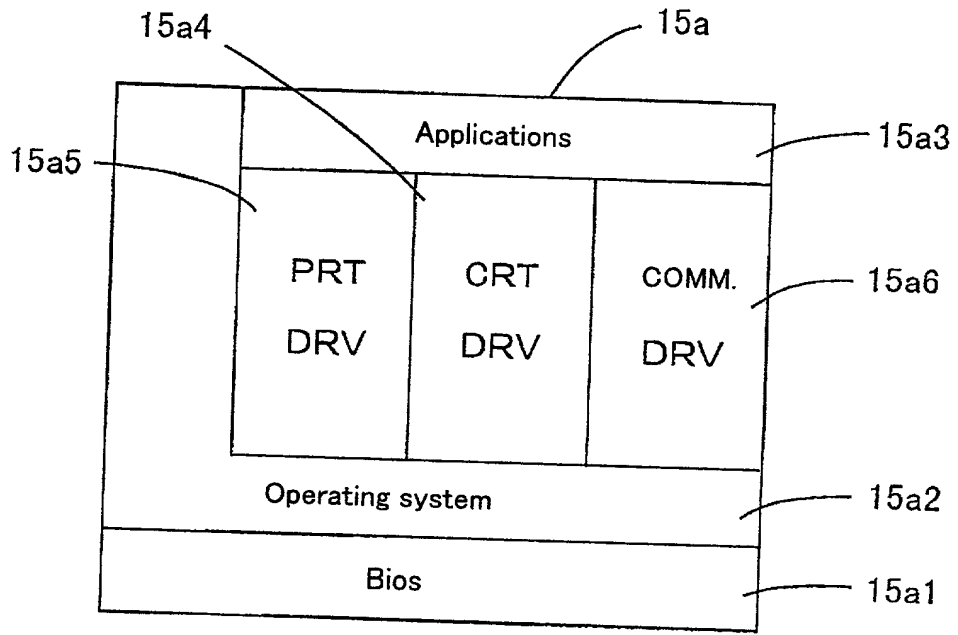

FIG.3



09922650

FIG.4

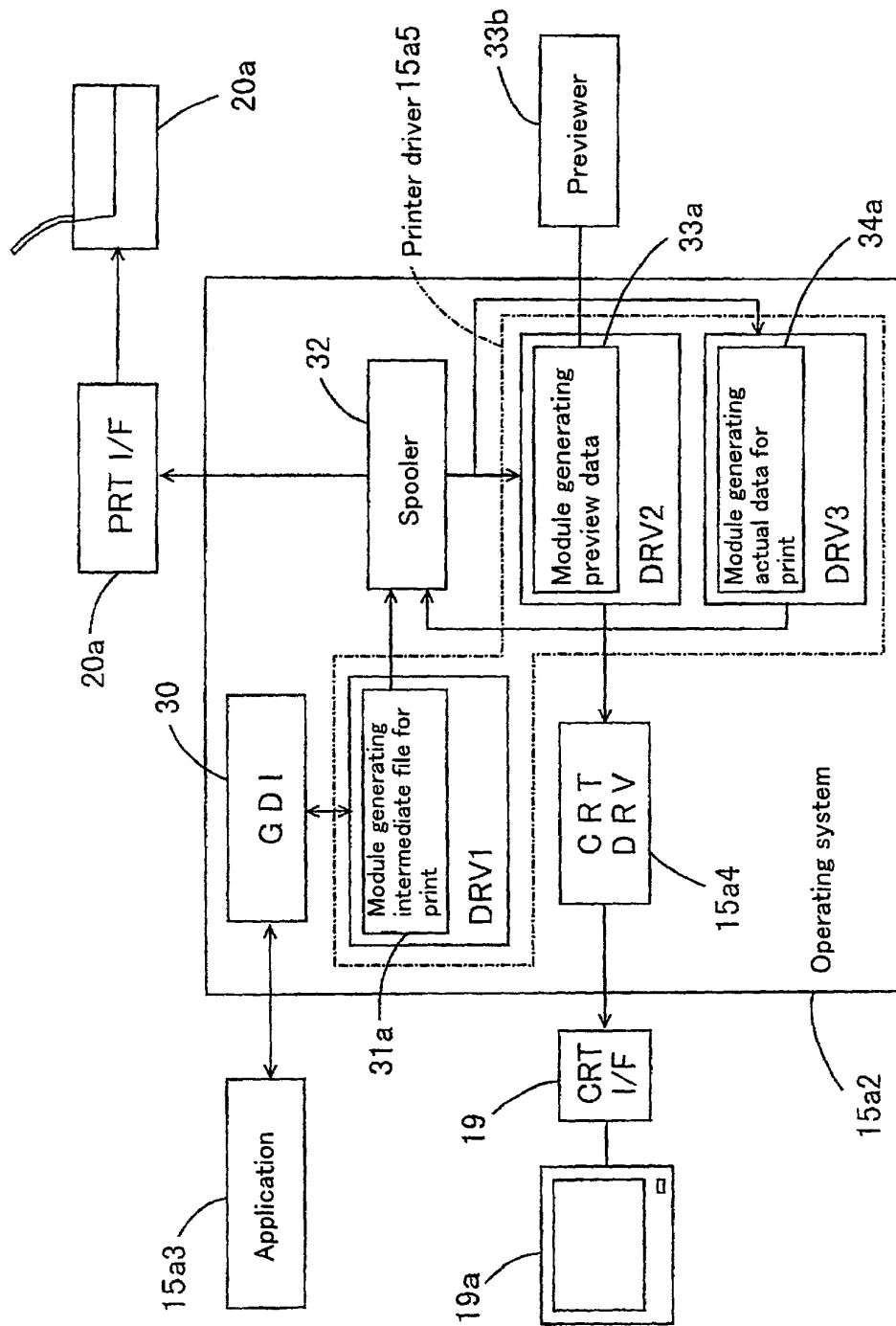
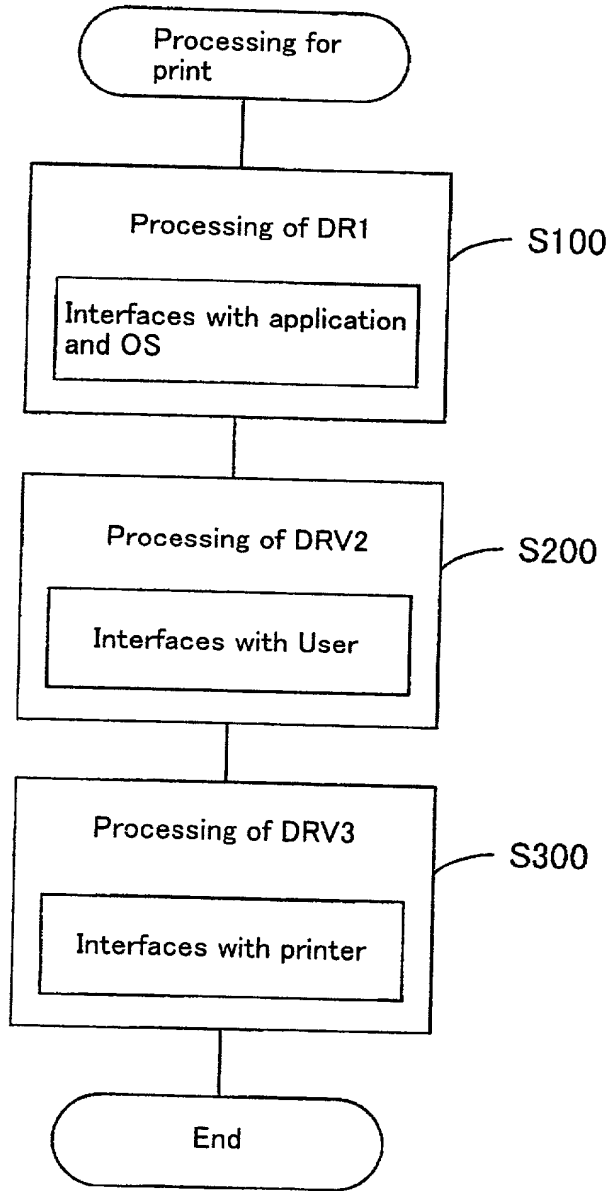
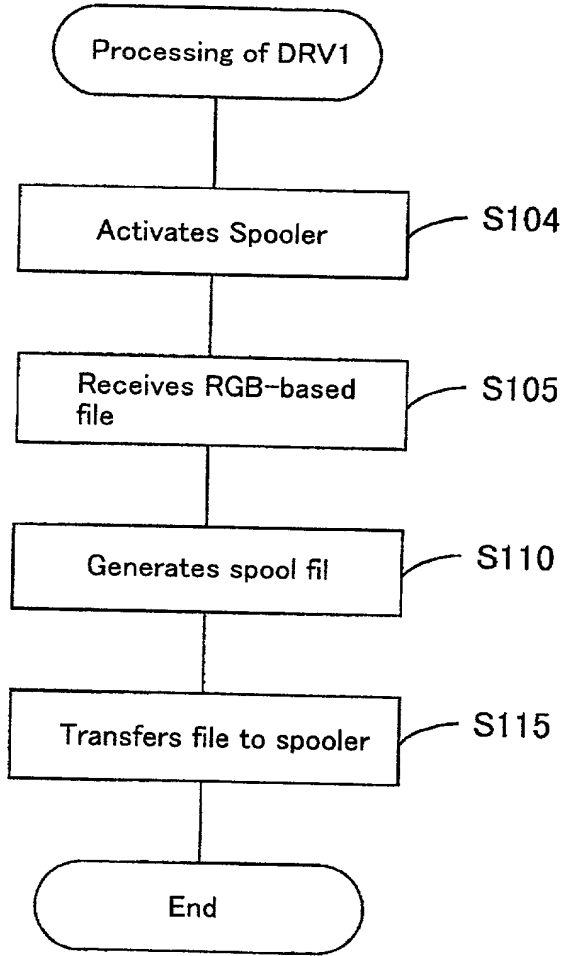

FIG.5



09922657.0007.01

FIG.6



092657077
"080" 292660

FIG. 7

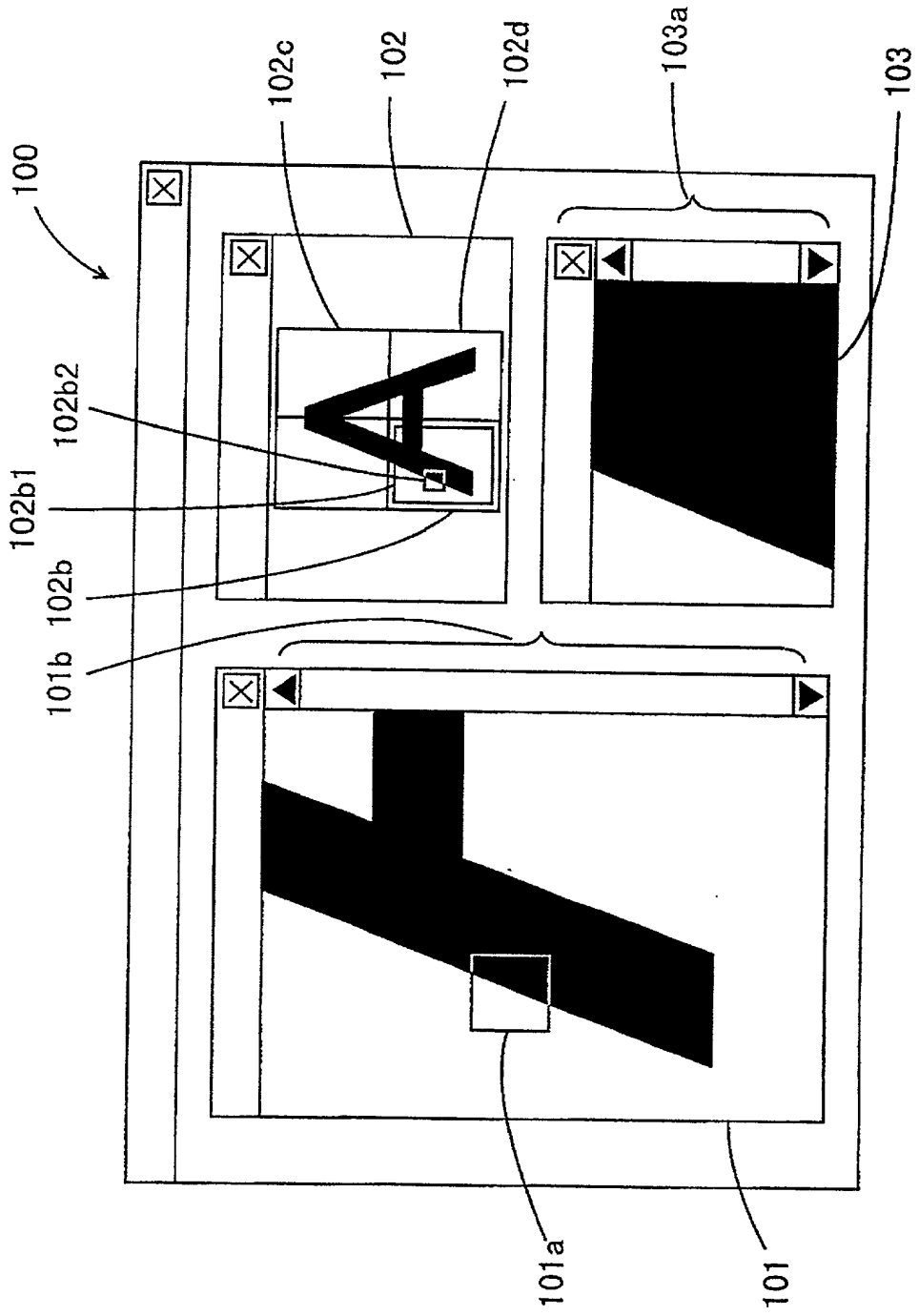
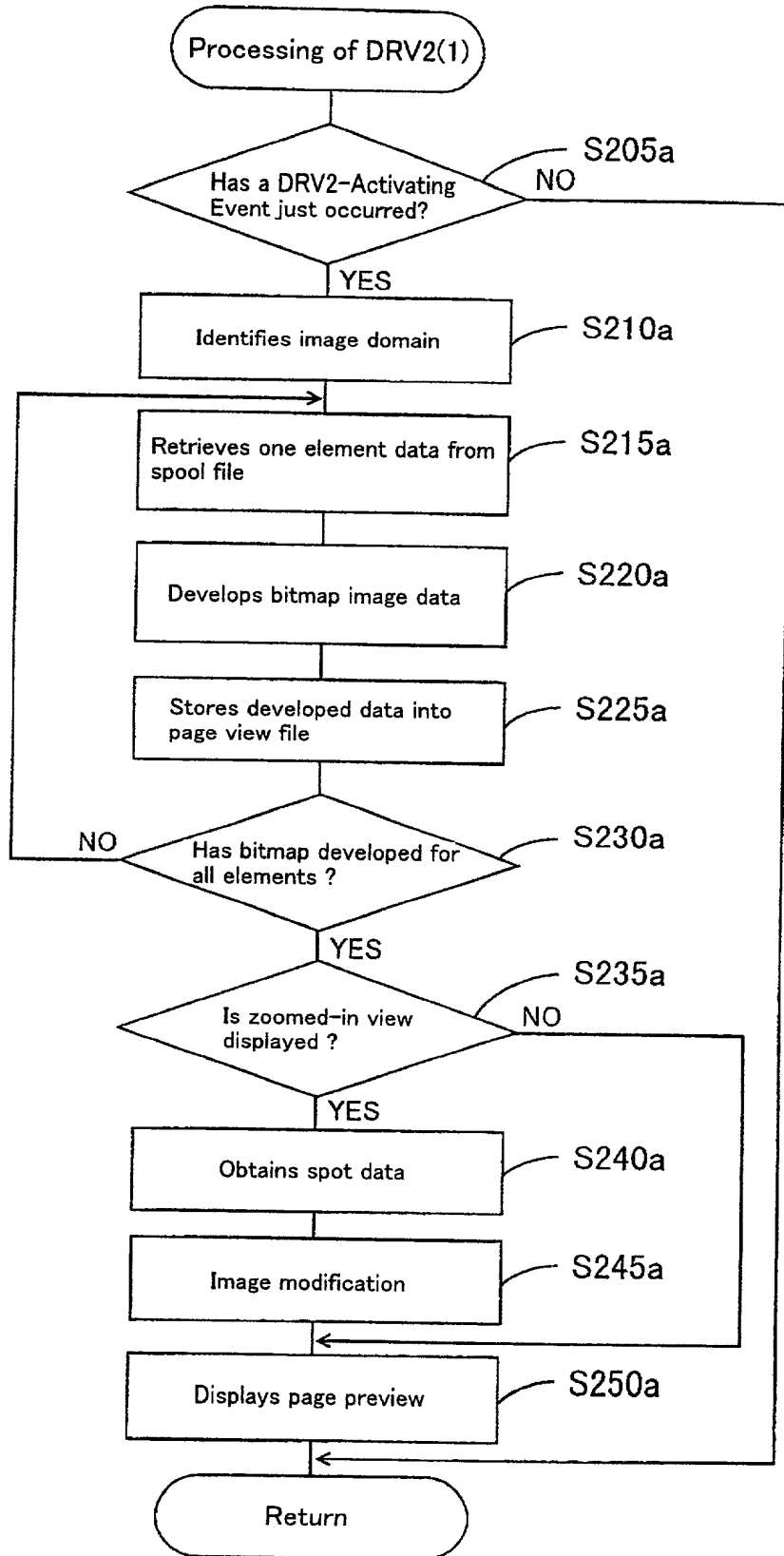
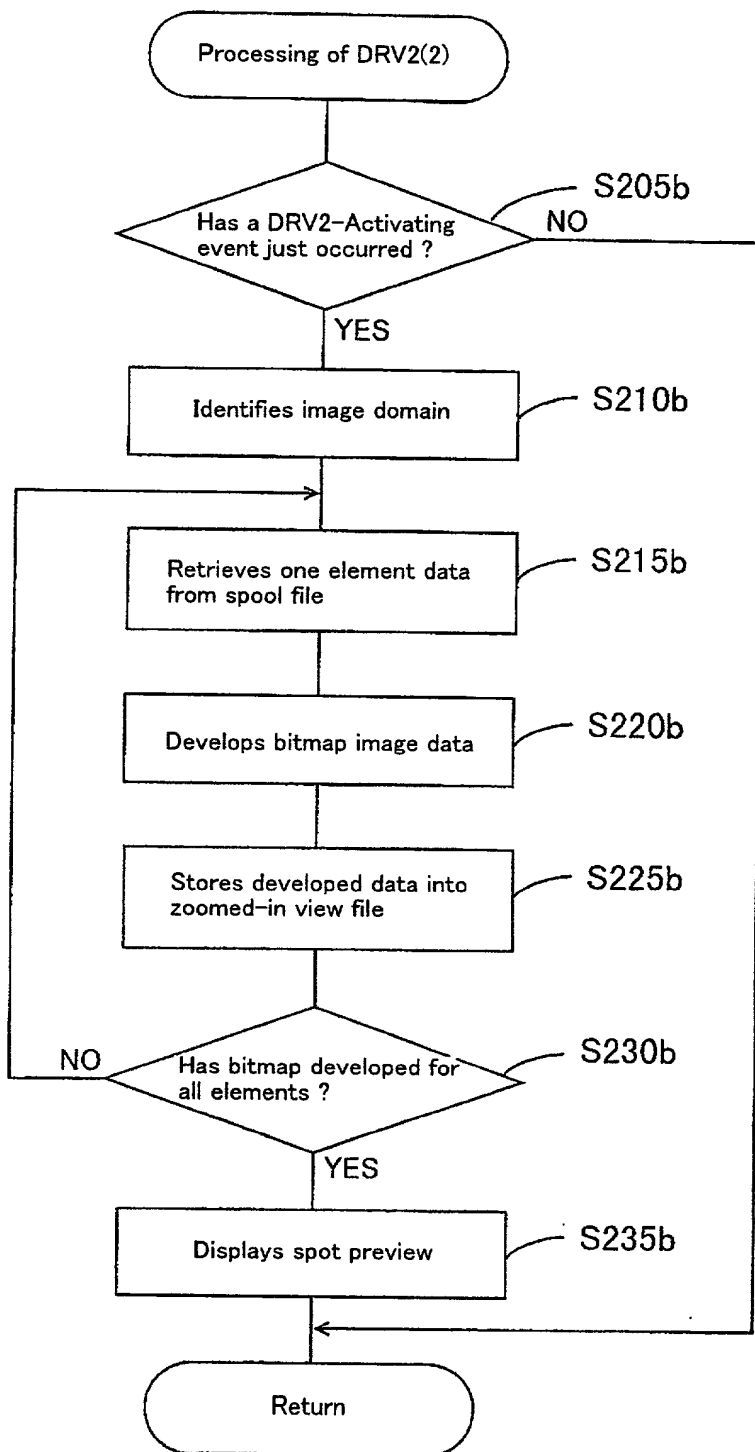

FIG.8



FORN 2522660

FIG.9



FOR "092504" 452266

FIG.10

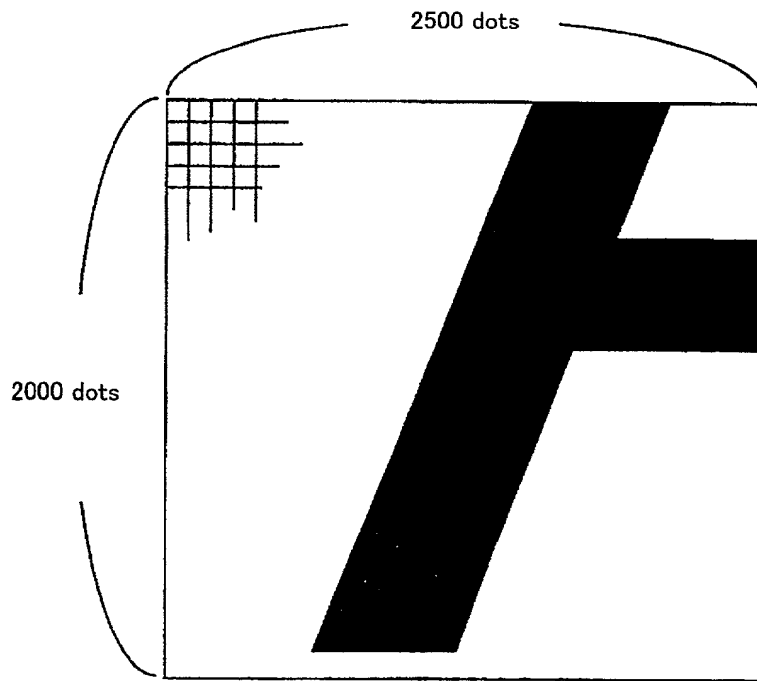

0922657.080701

FIG.11

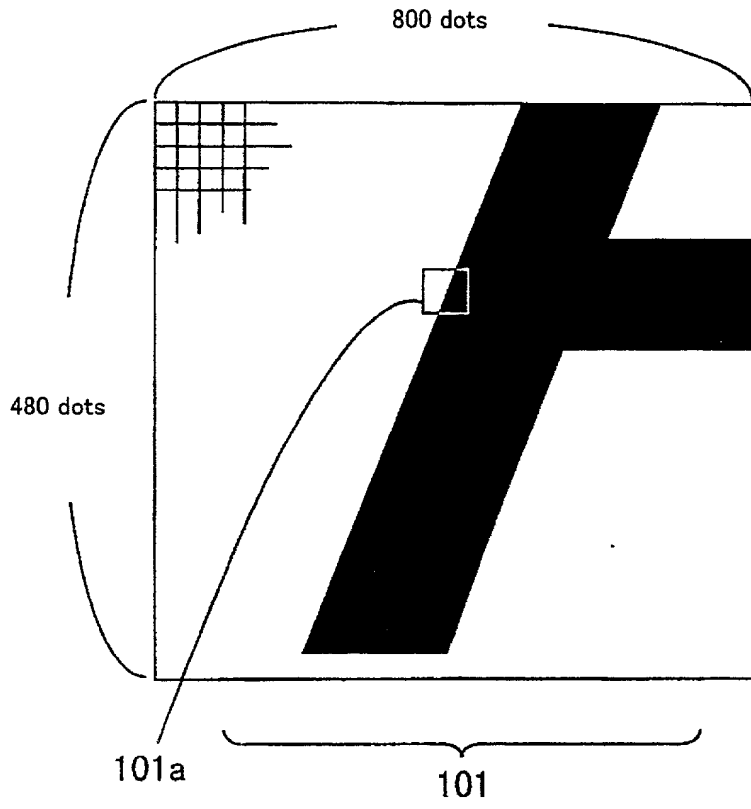

FO/080" 25922650

FIG.12

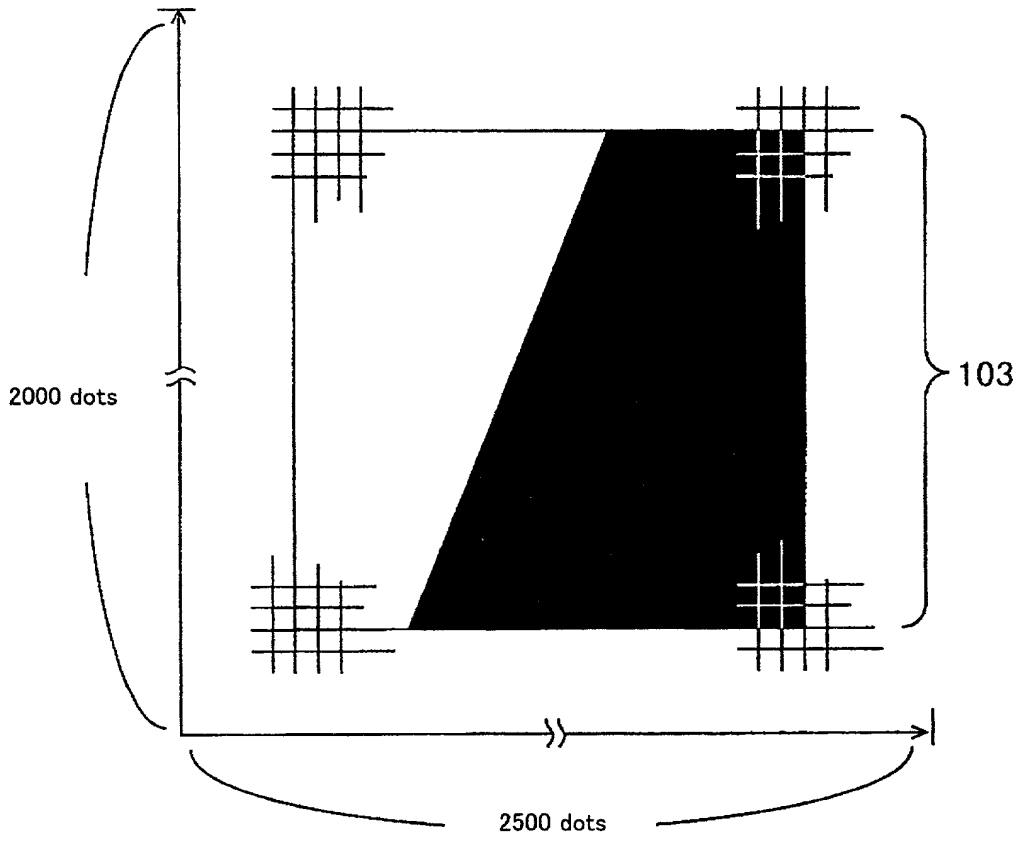

092257 080704
T07080 25922650

FIG.13

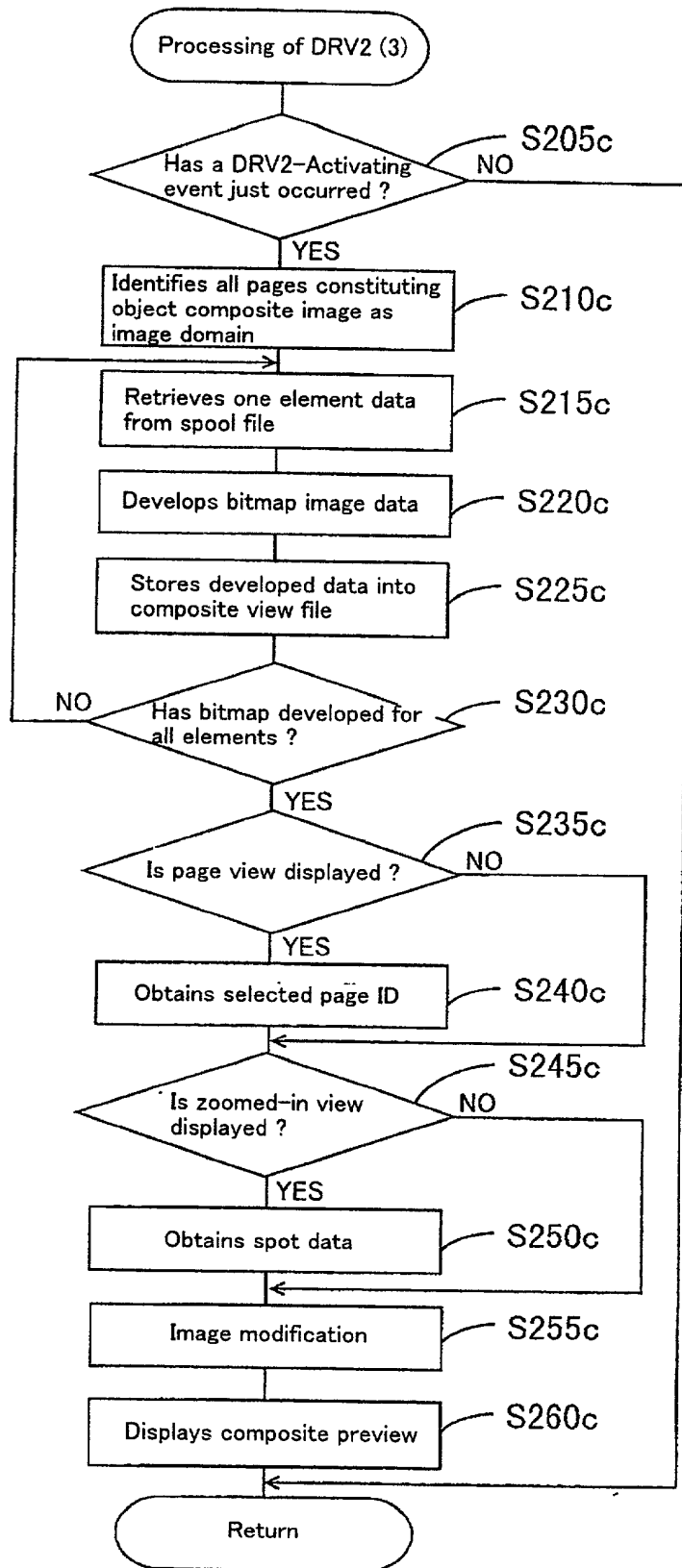

09922657 080701

FIG.14

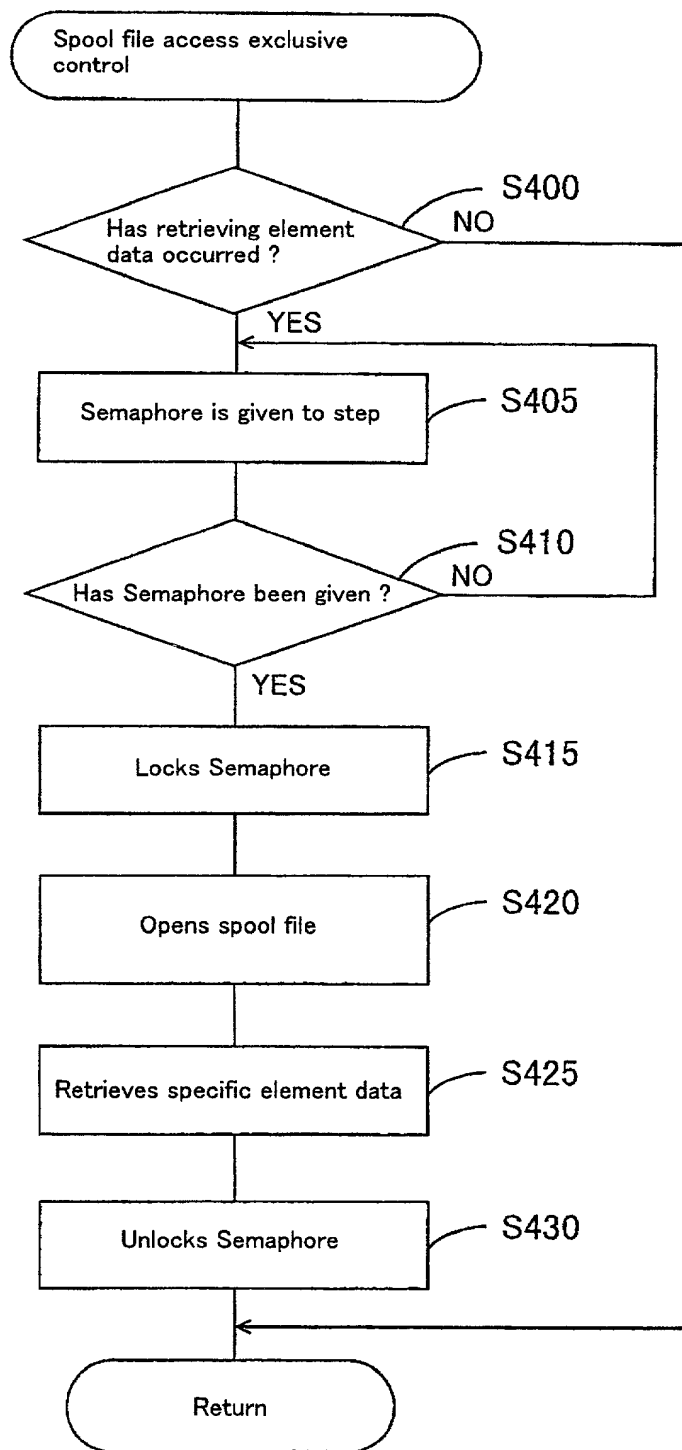

092657.00701
"02020" 25922660

FIG.15

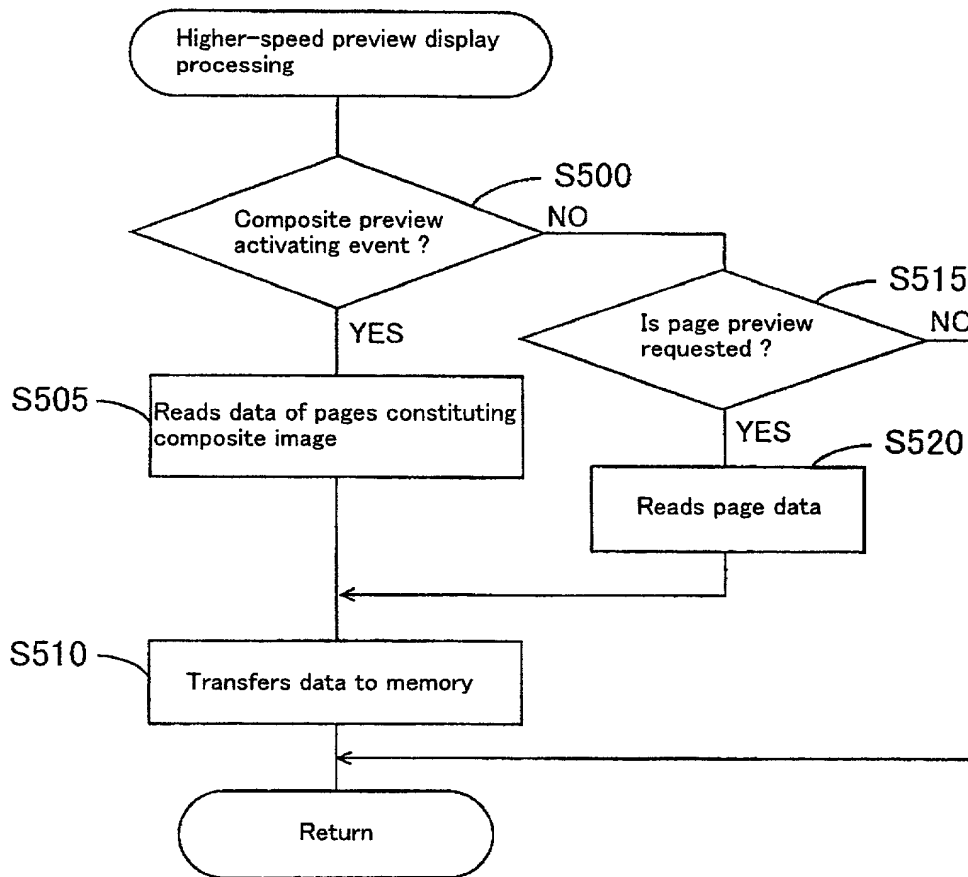

TOP SECRET

FIG.16

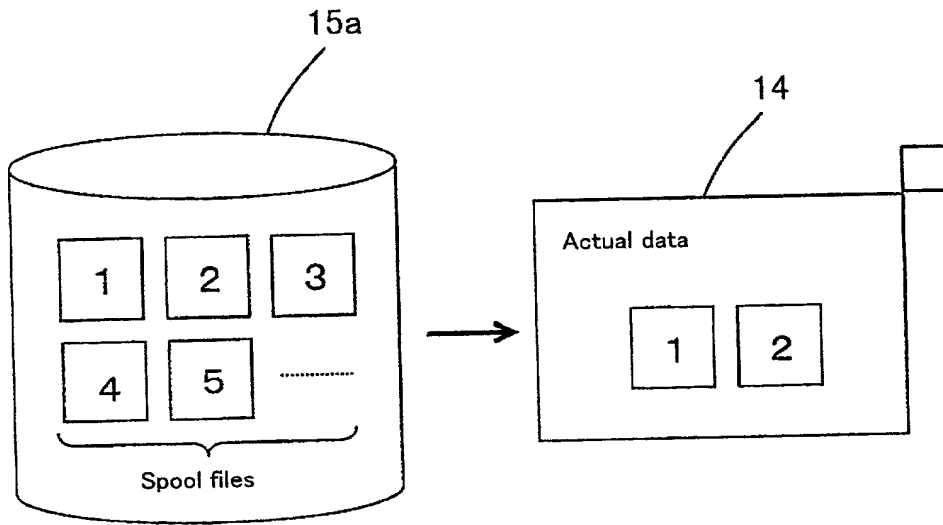
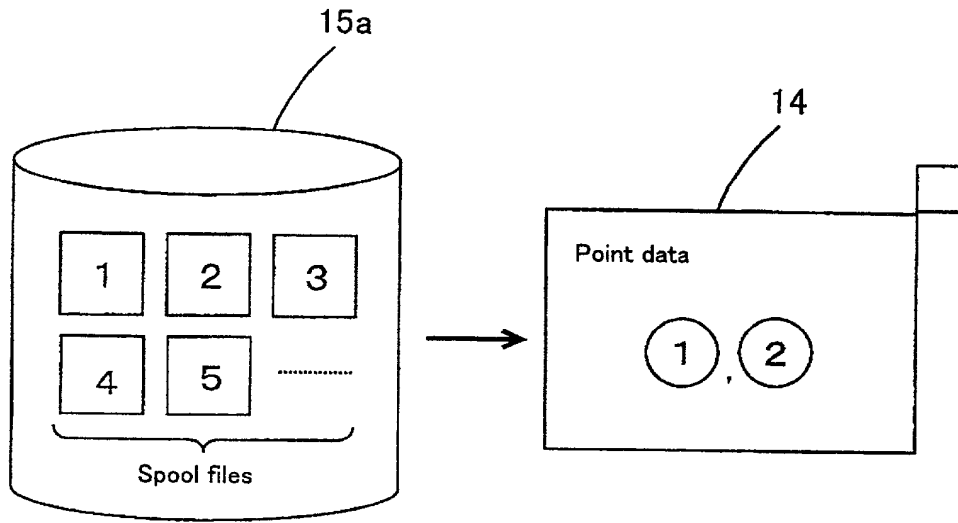

FIG. 16

FIG.17



0992257.080704

FIG.18

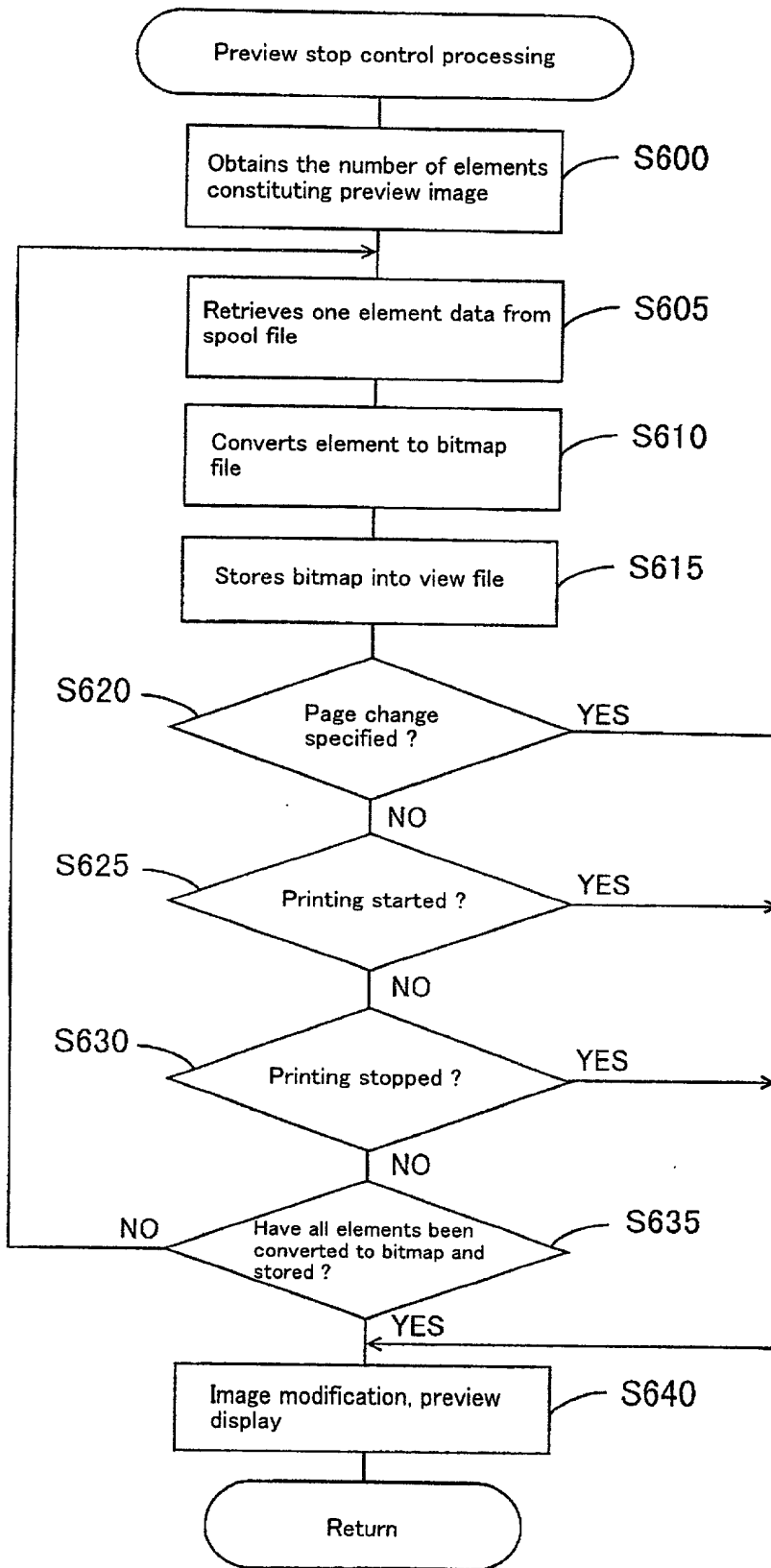

09922660

FIG.19

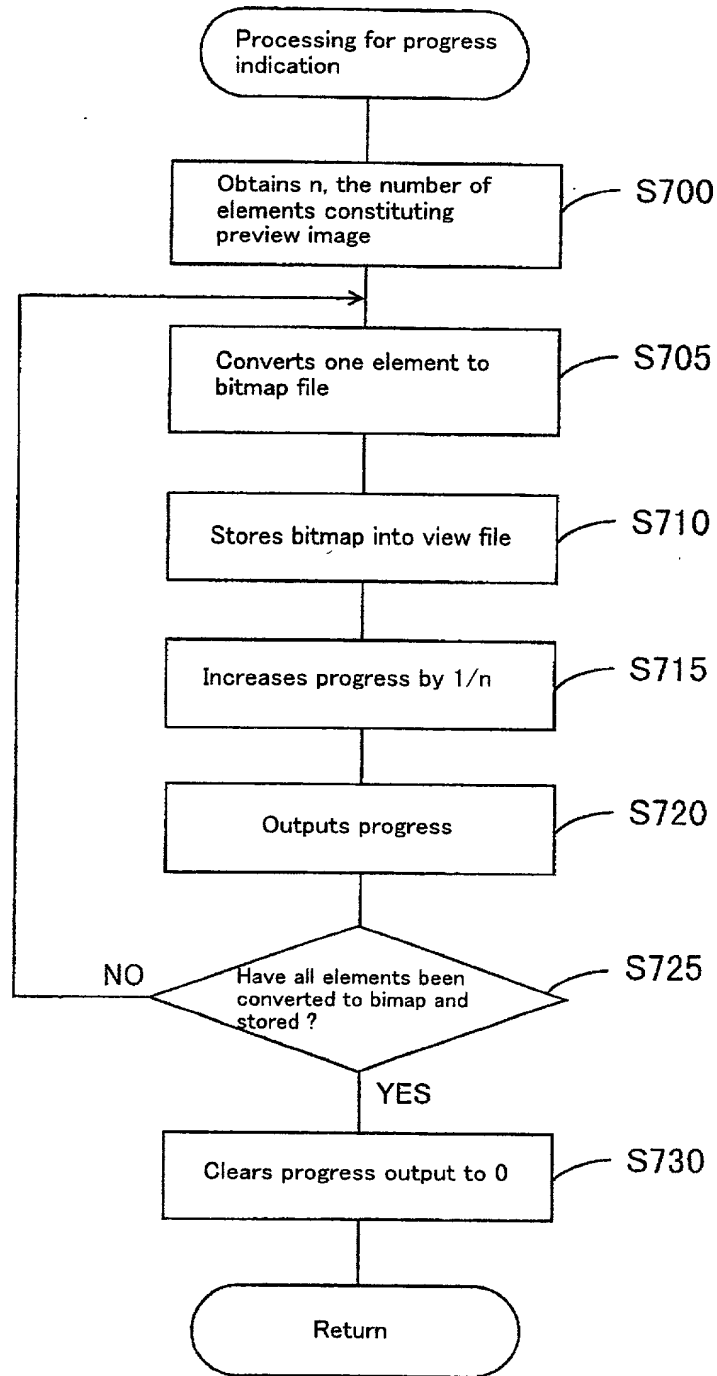

092657 2592660

FIG.20

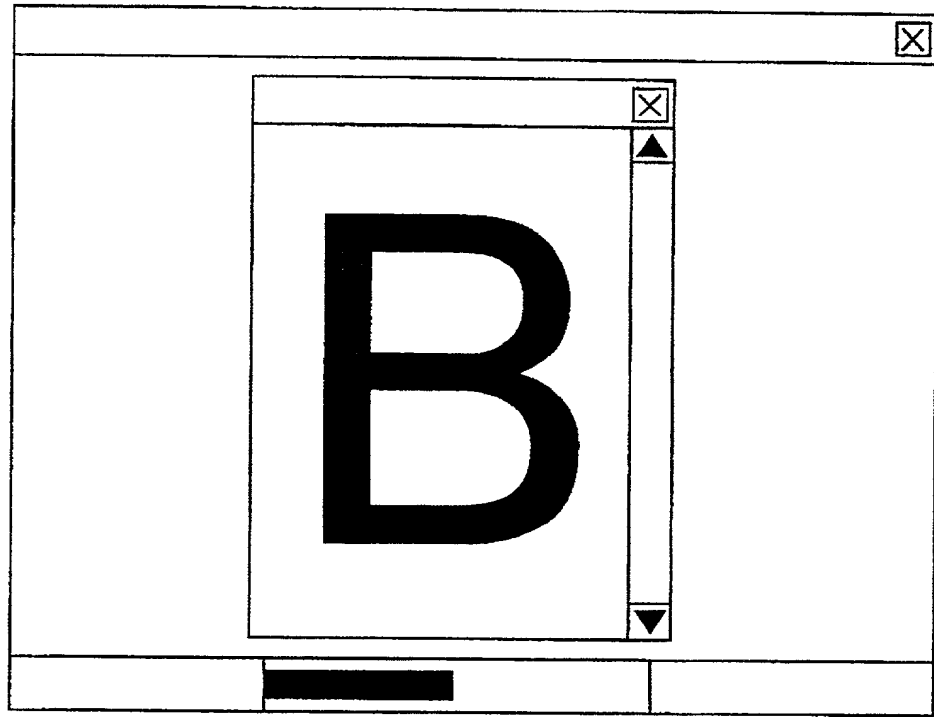

Progress indicator 200

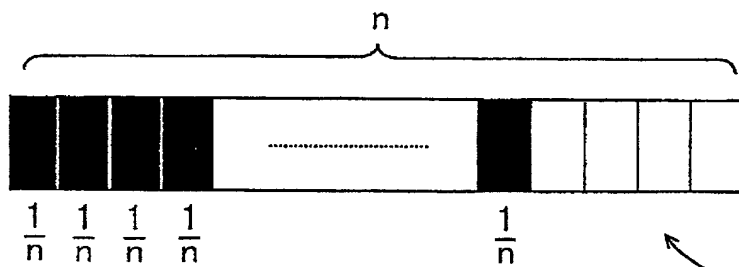

200

092257-00701
107000-7532660

FIG.21

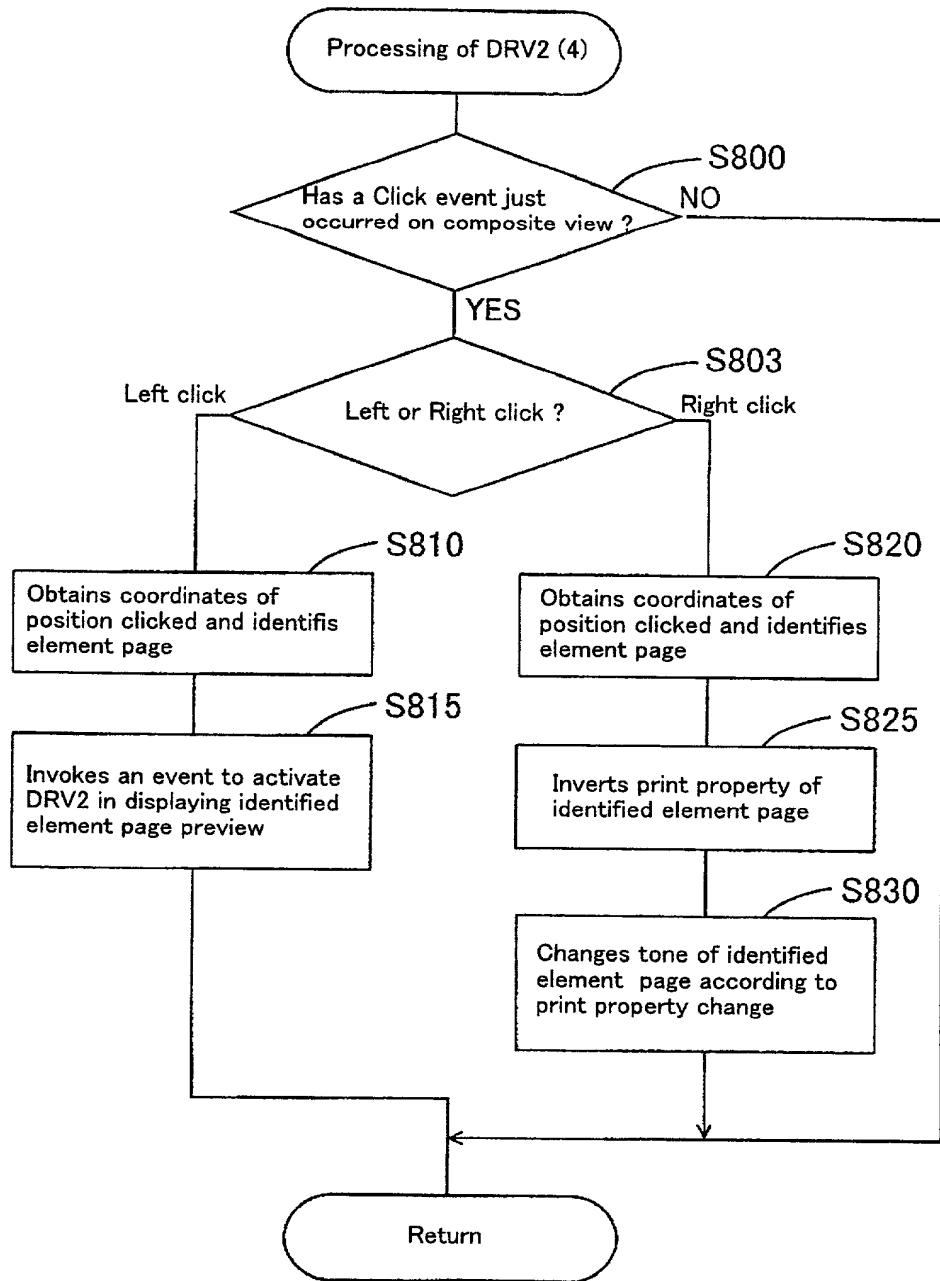

0992657 090704 707020 7592660

FIG.22

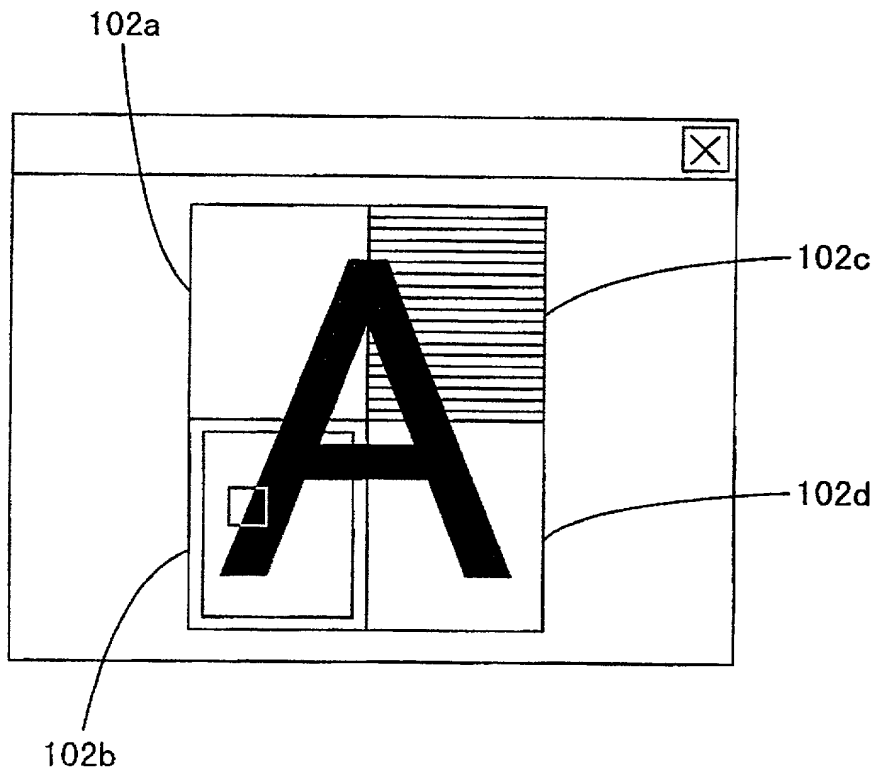

092657-080701
707080-25922560